

Tecnodin **Manillas**

Pág.		Pág.		Pág.	
53		56		59	
53		56		59	
53		56		59	
53		56		60	
54		57		60	
54		57		60	
54		57		60	
54		58			
55		58			
55		58			
55		58			
55		59			

1136 MANILLA FIJA CON ESPIGA ROSCADA

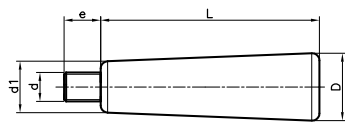

Código	D	d	d1	L	e	Color
113620501	20	M6	13	45	15	Negro
113624501	24	M8	16	53	15	Negro
113625501	25	M10	19	76	15	Negro
113628501	28	M12	21	92	15	Negro

Espiga roscada de acero tratado.
PF: Resina fenólica negra FS 31 DIN 7708.

1137 MANILLA GIRATORIA CON ESPIGA ROSCADA

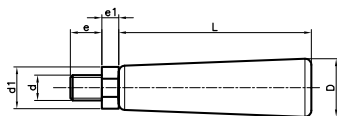

Código	D	d	d1	L	e	e1	Color
113720501	20	M6	13	45	12	5	Negro
113724501	24	M8	16	53	15	5,5	Negro
113725501	25	M10	19	76	15	6,5	Negro
113728501	28	M12	21	92	15	7	Negro

Espiga roscada de acero tratado.
PF: Resina fenólica negra FS 31 DIN 7708.

1140 MANILLA GIRATORIA GRAFILADA

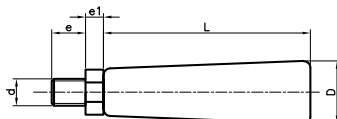

Código	D	L	d	e	e1	Color
114015501	15	50	M6	11	5	Negro
114017501	17	60	M8	13	6	Negro
114020501	20	70	M10	18	7	Negro
114023501	23	80	M12	19	8	Negro

Espiga de hierro tratado.
Termoplástico color negro.

1141 MANILLA GIRATORIA LISA CON ESPIGA ROSCADA



Código Negro	Código Naranja	Código Rojo	Código Azul	Código Amarillo	D	L	d	e	e1
114115501	114115541	114115551	114115521	114115531	15	50	M6	11	5
114117501	114117541	114117551	114117521	114117531	17	60	M8	13	6
114120501	114120541	114120551	114120521	114120531	20	70	M10	18	7
114123501	114123541	114123551	114123521	114123531	23	80	M12	19	8

Espiga roscada de acero tratado.
PP negro y tapones en los siguientes colores: negro, naranja, rojo, azul y amarillo. (Similares a los colores RAL indicados).

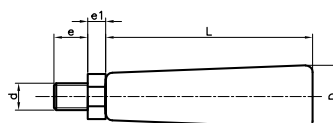

	RAL 7021 Negro
	RAL 2004 Naranja
	RAL 3001 Rojo
	RAL 5005 Azul
	RAL 1021 Amarillo

1144C MANGO CÓNICO CON ROSCA DIRECTA

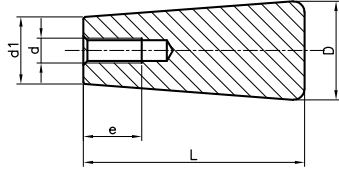

Código	D	L	d	e	d1	Color
114410101	10	85	W 5/32"	10	8	Negro
114413101	13	30	M5	10	10	Negro
114420101	20	45	M6	14	13	Negro
114424101	24	53	M6	14	16	Negro
114425101	25	76	M8	20	19	Negro
114428101	28	92	M10	22	21	Negro
114430101	30	132	M12	25	23,5	Negro

Rosca directa.

PF: Resina fenólica negra FS 31 DIN 7708.

1144P MANGO CÓNICO CON AGUJERO PASANTE LISO

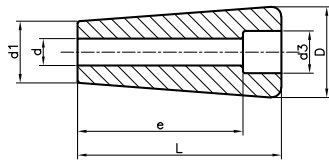

Código	D	L	d	e	d1	d3	Color
114413201	13	30	5	23,2	10	8,5	Negro
114415201	15	50	6	40	12	8,8	Negro
114417201	17	60	8	48	14	10	Negro
114420201	20	45	6	37,5	13	9,7	Negro
114421201	20	70	8	56	16	10,8	Negro
114423201	23	80	10	65	18,5	14	Negro
114424201	24	53	7	43	16	11	Negro

Agujero pasante liso.

PF: Resina fenólica negra FS 31 DIN 7708.

1145 MANGO BARRIL CON ROSCA DIRECTA

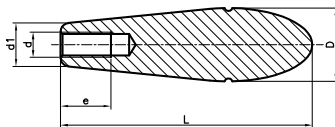

Código	D	L	d	e	d1	Color
114535101	35	95	M12	24	20	Negro
114539101	35	120	M12	24	20	Negro

Rosca directa.

PF: Resina fenólica negra FS 31 DIN 7708.

1175 PALANCA PASANTE

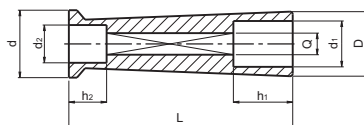

Código	D	L	Q	d	d1	h1	d2	h2	Color
117524201	24	83	8x8	25	17	22	14	20	Negro
117528201	28	90	10x10	28	18	25	14	20	Negro

Q = taladro cuadrado.

Resina fenólica FS 31 DIN 7708, color negro.

3310 DIN 39-E MANILLA FIJA DE ALUMINIO CON ESPIGA ROSCADA

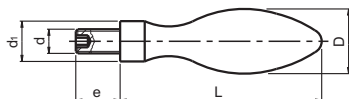

Código	D	d	d1	L	e	Acabado
331016501	16	M6	10	50	11	Pulido
331020501	20	M8	13	64	13	Pulido
331025501	25	M10	16	80	14	Pulido
331032501	32	M12	20	100	16	Pulido

Espiga roscada de acero.
AL: Aluminio pulido.

3311 DIN 39-E MANILLA FIJA DE POLIAMIDA CON ESPIGA ROSCADA

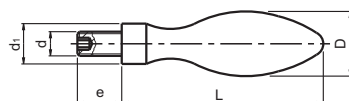

Código	D	d	d1	L	e	Color
331120501	20	M8	13	64	13	Negro
331125501	25	M10	16	80	14	Negro
331132501	32	M12	20	100	16	Negro

Espiga roscada de acero.
PA: Poliamida reforzada.

3312 DIN 98-E MANILLA GIRATORIA DE ALUMINIO CON ESPIGA ROSCADA

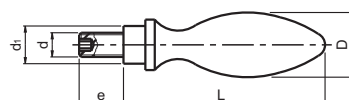

Código	D	d	d1	L	e	Acabado
331216501	16	M6	10	54	11	Pulido
331220501	20	M8	13	67	13	Pulido
331225501	25	M10	16	83	14	Pulido
331232501	32	M12	20	105	16	Pulido
331236501	36	M16	22	117	26	Pulido

Espiga roscada de acero.
AL: Aluminio pulido.

3313 DIN 98-E MANILLA GIRATORIA DE POLIAMIDA CON ESPIGA ROSCADA

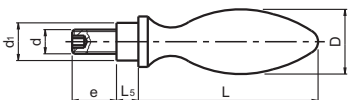

Código	D	d	d1	L	e	L5	Color
331316501	16	M6	10	49	11	5,5	Negro
331320501	20	M8	13	61	13	6	Negro
331325501	25	M10	16	75	14	8	Negro
331332501	32	M12	20	95	21	10,5	Negro

Espiga roscada de acero.
PA: Poliamida reforzada.

3314 MANILLA BICÓNICA FIJA DE ALUMINIO CON ESPIGA ROSCADA

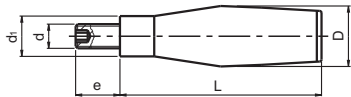

Código	D	d	d1	L	e	Acabado
331416501	16	M6	10	50	11	Pulido
331420501	20	M8	13	64	13	Pulido
331425501	25	M10	16	80	14	Pulido
331432501	32	M12	20	100	16	Pulido

Espiga roscada de acero.
AL: Aluminio pulido.

3316 MANILLA BICÓNICA GIRATORIA DE ALUMINIO CON ESPIGA ROSCADA

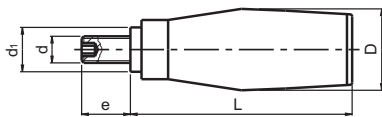

Código	D	d	d1	L	e	Acabado
331616501	18	M6	10	43	12	Pulido
331620501	20	M8	13	65	13	Pulido
331625501	25	M10	16	75	14	Pulido
331632501	32	M12	20	95	16	Pulido

Espiga roscada de acero.
AL: Aluminio pulido.

3710 DIN 39-E MANILLA FIJA DE ACERO CON ESPIGA ROSCADA

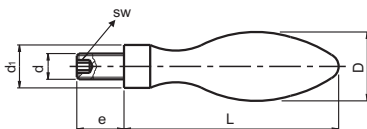

Código	D	L	d	d1	e	sw	Acabado
371016506	16	50	M6	10	11	3	Pulido
371020508	20	64	M8	13	13	4	Pulido
371025510	25	80	M10	16	14	5	Pulido
371032512	32	100	M12	20	21	6	Pulido
371036516	36	112	M16	22	26	8	Pulido

Espiga roscada de acero.
Fe: Acero torneado y pulido.

3712 DIN 98-E MANILLA GIRATORIA DE ACERO CON ESPIGA ROSCADA

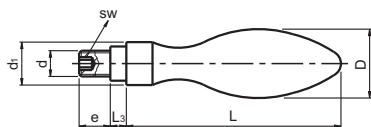

Código	D	d	d1	L	e	L3	sw	Acabado
371216506	16	M6	14	49	11	5,5	3	Pulido
371220508	20	M8	18	61	13	6	4	Pulido
371225510	25	M10	21	75	14	8	5	Pulido
371232512	32	M12	26	95	21	10,5	6	Pulido
371236516	36	M16	29	106	26	11	8	Pulido

Espiga roscada de acero.
Fe: Acero torneado y pulido.

3738 MANILLA GIRATORIA DE BAQUELITA CON ESPIGA ROSCADA

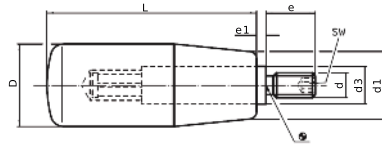

Código	D	L	d1	d3	d	e	e1	sw	Color
373800010	18	40	15	10	M6	12	2,5	3	Negro
373800020	21	50	17	10	M6	13	2,5	3	Negro
373800031	22	56	18	10	M8	13	2,5	4	Negro
373800041	23	65	19	13	M10	14	2,5	5	Negro
373800051	26	80	21	13	M10	16	2,5	5	Negro
373800071	31	102	25	14	M12	20	2,5	6	Negro

Espiga roscada de acero tratado.
PF: Resina fenólica negra FS 31 DIN 77.

3738 MANILLA GIRATORIA DE BAQUELITA CON ESPIGA ROSCADA EN INOX

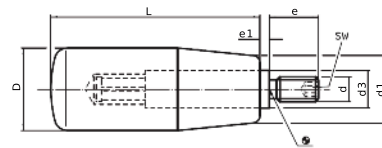

INOX
Acero
Inoxidable

Código	D	L	d1	d3	d	e	e1	sw	Color
373800210	18	40	15	10	M6	12	2,5	3	Negro
373800220	21	50	17	10	M6	13	2,5	3	Negro
373800240	23	65	19	13	M8	14	2,5	4	Negro
373800251	26	80	21	13	M10	16	2,5	5	Negro
373800271	31	102	25	14	M12	20	2,5	6	Negro

Espiga roscada de acero inoxidable.
PF: Resina fenólica negra FS 31 DIN 7708.

4708 MANILLA GIRATORIA EM



Código	D	d	L	d1	d2	d3	Q	h3	Color	Tapón
470806010	40	M10	64	22,5	22	20,5	40	34,5	Negro	Gris

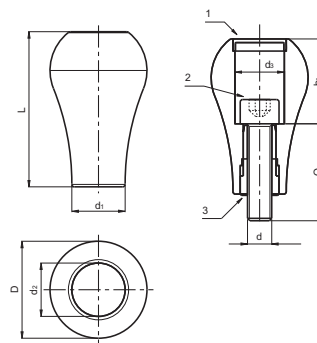

Casquillo interior (3) y tornillo (2) DIN 912 de acero zincado.
Poliamida negra reforzada y tapón (1) color gris (RAL 7035).
La manilla se suministra sin montar.

4733 MANILLA GIRATORIA TRCA 144 CON ESPIGA ROSCADA

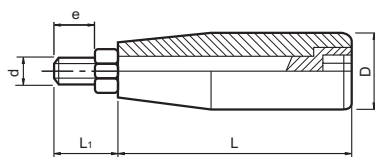

Código	D	d	L	L1	e	Color
473305006	20	M6	50	15	10	Negro
473306008	21	M8	59	21	15	Negro
473307008	23	M8	68	24	16	Negro
473308010	25	M10	79	23	15	Negro
473309012	28	M12	90	24	17	Negro

Espiga roscada de acero pavonado.
PA: Poliamida negra reforzada.

4733 MANILLA GIRATORIA TRCA 144 CON ESPIGA ROSCADA EN INOX

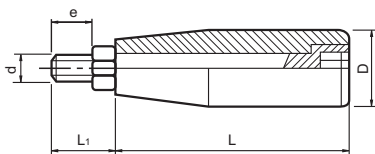

INOX
Acero
Inoxidable

Código	D	d	L	L1	e	Color
473305106	20	M6	50	15	10	Negro
473306108	21	M8	59	21	15	Negro
473307108	23	M8	68	24	16	Negro
473308110	25	M10	79	23	15	Negro
473309112	28	M12	90	24	17	Negro

Espiga de acero inoxidable AISI 304
(Tuerca AISI 303).
PA: Poliamida negra reforzada.

4734 MANILLA GIRATORIA TMP CON ESPIGA ROSCADA

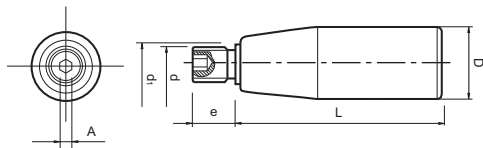

Código	D	d1	d	L	e	A	Color
473405006	20	10	M6	51,5	12	3	Negro
473406008	23	10	M8	61,5	15	4	Negro
473407008	25	10	M8	71,5	15	4	Negro
473407010	25	10	M10	71,5	15	4	Negro
473408010	26	14	M10	81,5	15	5	Negro
473409012	27	14	M12	91,5	15	5	Negro

Espiga de acero cincado.
PA: Poliamida negra reforzada.

4735 MANILLA GIRATORIA PLEGABLE 136

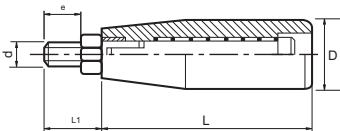

Código	D	d	L	L1	e	Color
473505006	20	M6	49	14	9	Negro
473507008	25	M8	69	16,5	10	Negro
473508010	26	M10	81	23	15	Negro
473509010	26	M10	89	23	15	Negro

Espiga de acero de decoletaje, pavonada.
PA: Poliamida negra reforzada.

3802T ESPIGA ROSCADA CON POMO ESFÉRICO

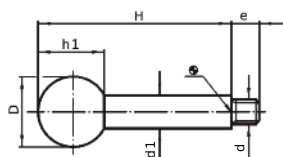

Código	d1	H	d	e	D	h1	Acabado
380200022	8	80	M6	9	20	18	Pavonado
380200032	10	100	M8	11	25	22,5	Pavonado
380200042	12	125	M10	14	32	29	Pavonado
380200052	14	160	M12	16	35	32,5	Pavonado
380200062	16	200	M14	18	40	37	Pavonado

Espiga roscada de acero rectificado, pavonado.
Esfera (DIN 319) de resina fenólica FS 31, negra.

3802T SS ESPIGA ROSCADA INOXIDABLE CON POMO ESFÉRICO



INOX
Acero
Inoxidable

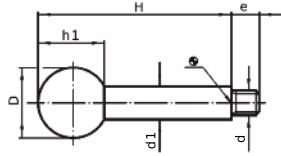

Código	d1	H	d	e	D	h1	Acabado
380200522	8	80	M6	9	20	18	Pulido mate
380200532	10	100	M8	11	25	22,5	Pulido mate
380200542	12	125	M10	14	32	29	Pulido mate
380200552	14	160	M12	16	35	32,5	Pulido mate

Espiga roscada de acero inoxidable 1.4305.
Esfera (DIN 319) de resina fenólica FS 31, negra.

4743T ESPIGA ROSCADA CON MANGO CILÍNDRICO



Espiga roscada de acero cincado.
Mango cilíndrico de poliamida negra reforzada.

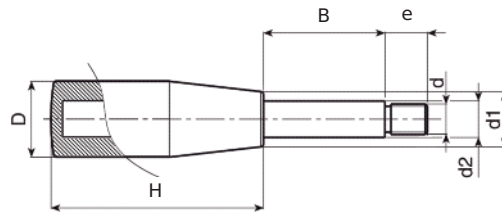

Código	D	H	d	e	d1	d2	B	Color
474320502	20	50	M8	10	15	10	45	Negro
474323502	23	60	M10	15	18	12	50	Negro
474325501	25	70	M12	15	19	14	50	Negro
474326502	26	80	M12	15	20	14	90	Negro
474327503	27	90	M14	17	22	16	100	Negro

4142 PUÑO 4142 P



Goma SBR 50 Shore.

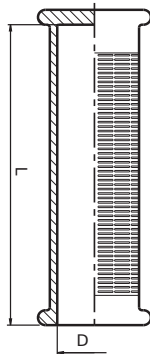

Código	D	L	Color
414225103	25	103	Negro
414227103	27	103	Negro
414230103	30	103	Negro

4143 PUÑO 4143 P



Goma SBR 60 Shore.

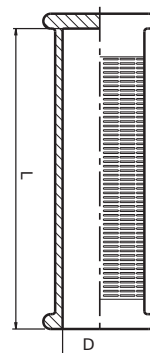

Código	D	L	Color
414330125	30	125	Negro

4144 PUÑO 4144 P



PVC 75 Shore.

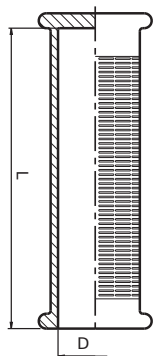

Código	D	L	Color
414422105	22	105	Negro
414424105	24	105	Negro

4717 PUÑO 4717 P



PE: Polietileno.

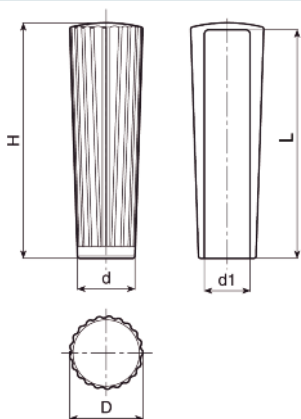

Código	D	d1	d	H	L	Color
471710101	32	20	25	104	100	Negro

4718 PUÑO 4718 P



PE: Polietileno.

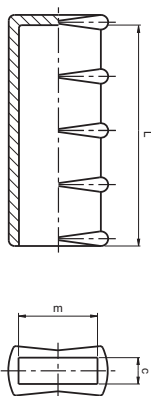

Código	L	c	m	Color
471807305	79	5	20	Negro
471807306	79	6	20	Negro
471807308	79	8	20	Negro
471807310	77	10	20	Negro
471810310	101	10	28	Negro
471810312	101	10	30	Negro

4709 EMPUÑADURA PM



PA: Poliamida reforzada.
*Sobre encargo se puede suministrar en color naranja.

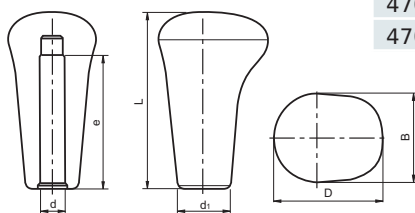

Código	D	B	d	d1	e	L	Color
470908012	50	40	10	26	58	80	Negro
470908014	50	40	12	26	62	80	Negro
470908016	50	40	14	26	60	80	Negro